

**HUFF-MORRIS ARCHITECTS**  
 A PROFESSIONAL CORPORATION  
 8 NORTH FIRST STREET  
 RICHMOND, VIRGINIA 23219  
 804.343.1505 VOICE HUFFMORRIS ? AOL.COM E.MAIL 804.343.1619 FAX

LIST OF EQUIPMENT					REMARKS
ITEM	QTY	STATUS	SUBMIT AS	DESCRIPTION	REVISED
1	1 EA	NEW	CUSTOM FABRICATION	BEVERAGE TABLE	
2	1 EA	N. I. C.	BY OWNER	COFFEE EQUIPMENT	
3	1 EA	N. I. C.	BY OWNER	COLD DRINK EQUIPMENT	
4	1 EA	N. I. C.	SPARE NUMBER		
5	1 EA	NEW	CATALOGED ITEM	ICE MACHINE	
6	1 EA	NEW	CATALOGED ITEM	HANDSINK	
7	1 EA	NEW	CATALOGED ITEM	WIRE SHELVING	
8	1 EA	NEW	CATALOGED ITEM	MIXER STAND	
9	1 EA	NEW	CATALOGED ITEM	MIXER	
10	1 EA	NEW	CATALOGED ITEM	COOLING RACK	
11	1 EA	NEW	CATALOGED ITEM	HEATED CABINET	
12	1 EA	N. I. C.	SPARE NUMBER		
13	1 EA	N. I. C.	SPARE NUMBER		
14	1 EA	NEW	CATALOGED ITEM	WIRE SHELVING	
15	1 EA	NEW	CATALOGED ITEM	FREEZER	
16	1 EA	NEW	CATALOGED ITEM	REFRIGERATOR	
17	1 EA	NEW	CATALOGED ITEM	COOLING RACK	
18	1 EA	NEW	CATALOGED ITEM	WIRE SHELVING	
19	1 EA	N. I. C.	SPARE NUMBER		
20	1 EA	NEW	CATALOGED ITEM	GAS RANGE	
21	1 EA	NEW	CATALOGED ITEM	CONVECTION OVEN	
22	1 EA	NEW	CUSTOM FABRICATION	EXHAUST HOOD	
23	1 EA	NEW	CUSTOM FABRICATION	FIRE SYSTEM	
24	1 EA	NEW	CATALOGED ITEM	WIRE SHELVING	
25	1 EA	N. I. C.	SPARE NUMBER		
26	1 EA	N. I. C.	SPARE NUMBER		
27	1 EA	NEW	CUSTOM FABRICATION	PREP TABLE	
28	1 EA	NEW	CUSTOM FABRICATION	MAKE UP TABLE	
29	2 EA	NEW	CATALOGED ITEM	SHEET PAN DOLLY	
30	1 EA	NEW	CUSTOM FABRICATION	MAKEUP TABLE	
31	1 EA	N. I. C.	SPARE NUMBER		
32	1 EA	N. I. C.	SPARE NUMBER		
33	1 EA	NEW	CATALOGED ITEM	HAND SINK	
34	1 EA	NEW	CATALOGED ITEM	WARE WASHER	
35	1 EA	NEW	CATALOGED ITEM	POT WASH SINK	
36	1 EA	N. I. C.	SPARE NUMBER		
37	1 EA	N. I. C.	SPARE NUMBER		
38	1 EA	N. I. C.	SPARE NUMBER		
39	1 EA	NEW	CATALOGED ITEM	REFRIGERATOR	
40	1 EA	NEW	CATALOGED ITEM	LANDING TABLE	
41	3 EA	NEW	CATALOGED ITEM	FOOD WARMER	

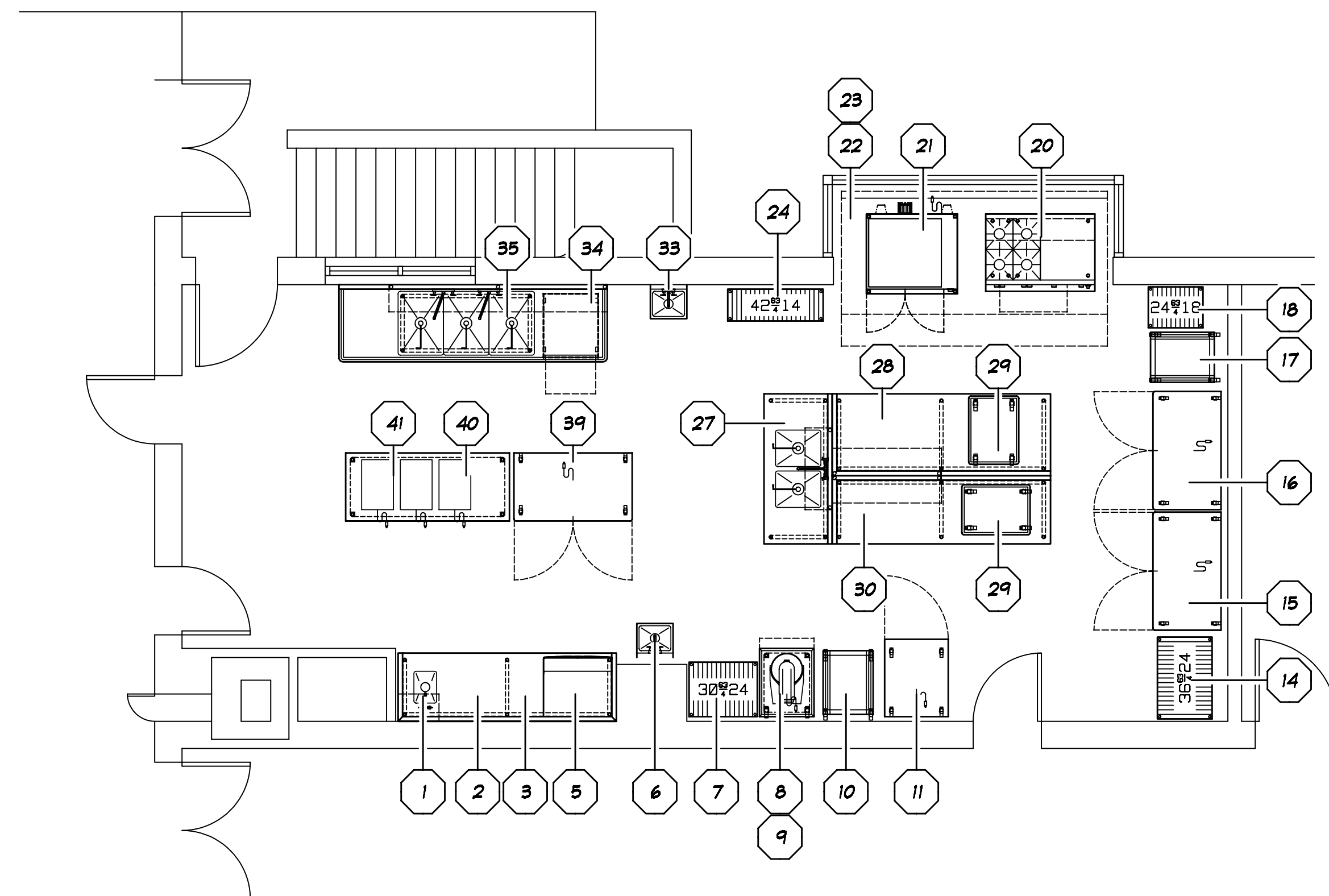

**PLAN VIEW**

1/4" = 1' - 0"

DATE: 12/18/20

REVISIONS:

**WESTOVER HILLS METHODIST**  
 RICHMOND, VA

FOOD SERVICE  
 MAIN KITCHEN

FILE NO.:

OF

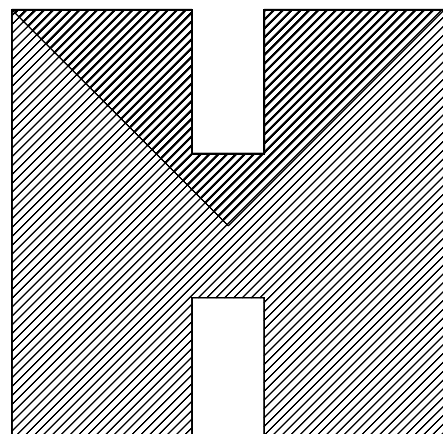
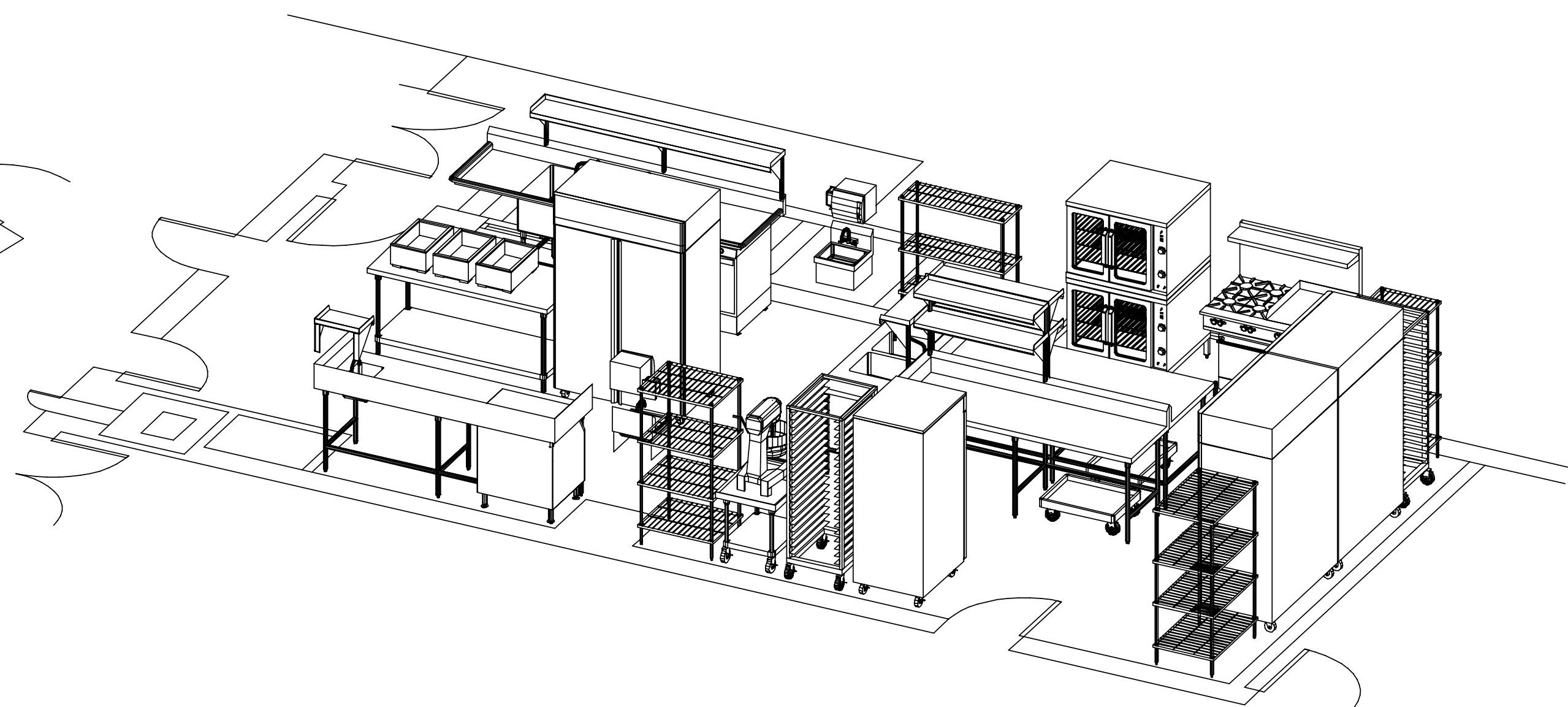
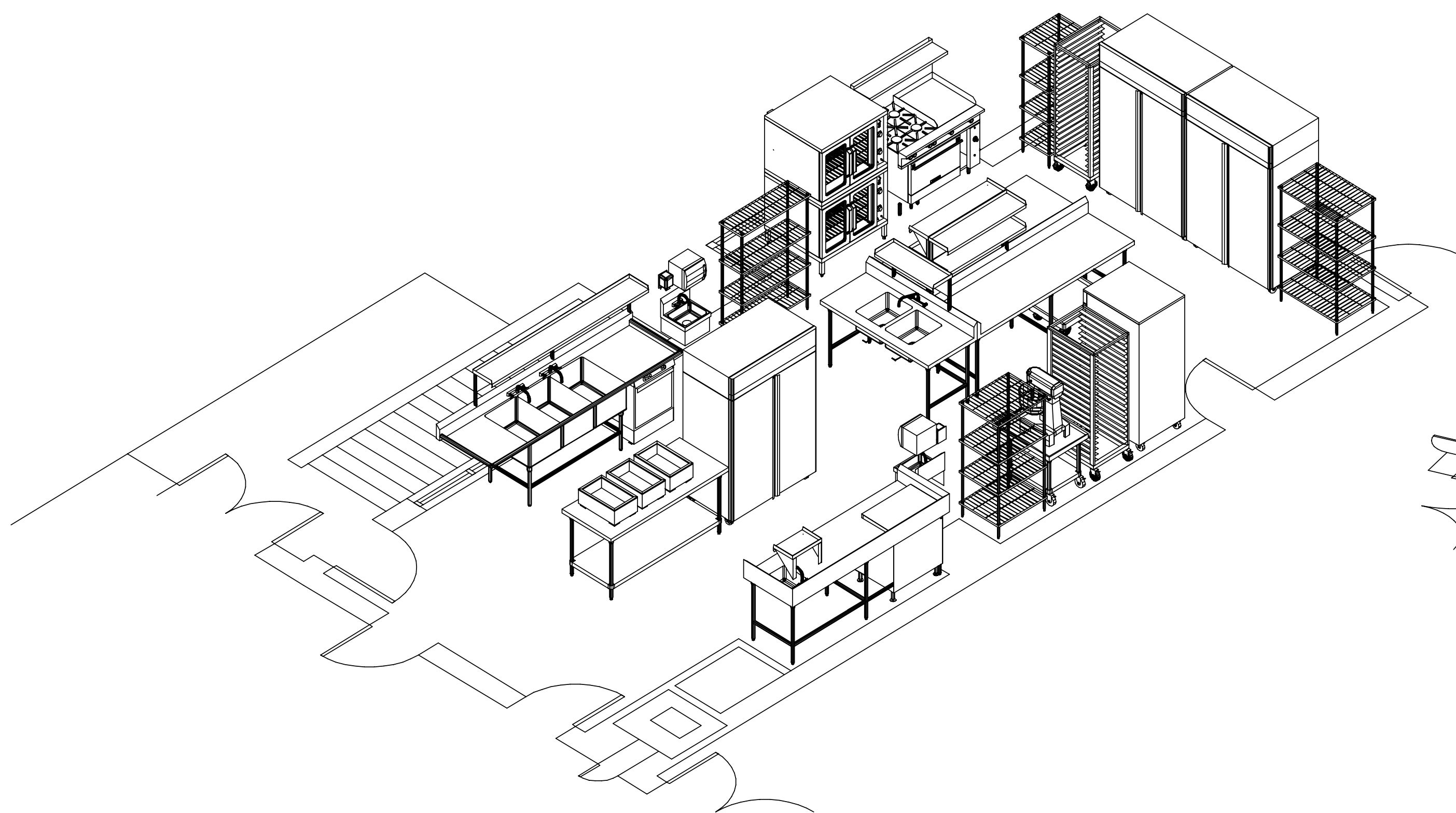
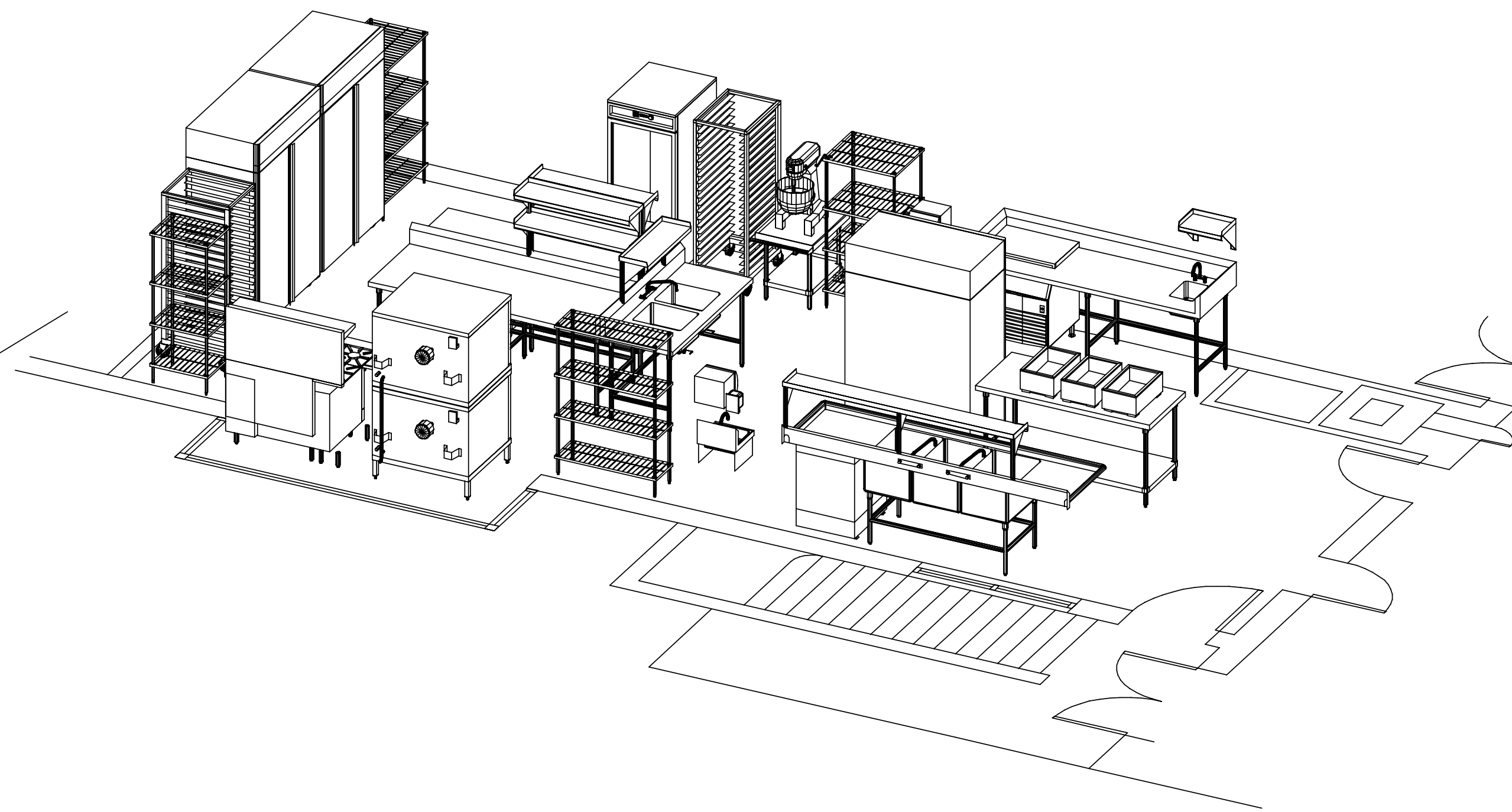
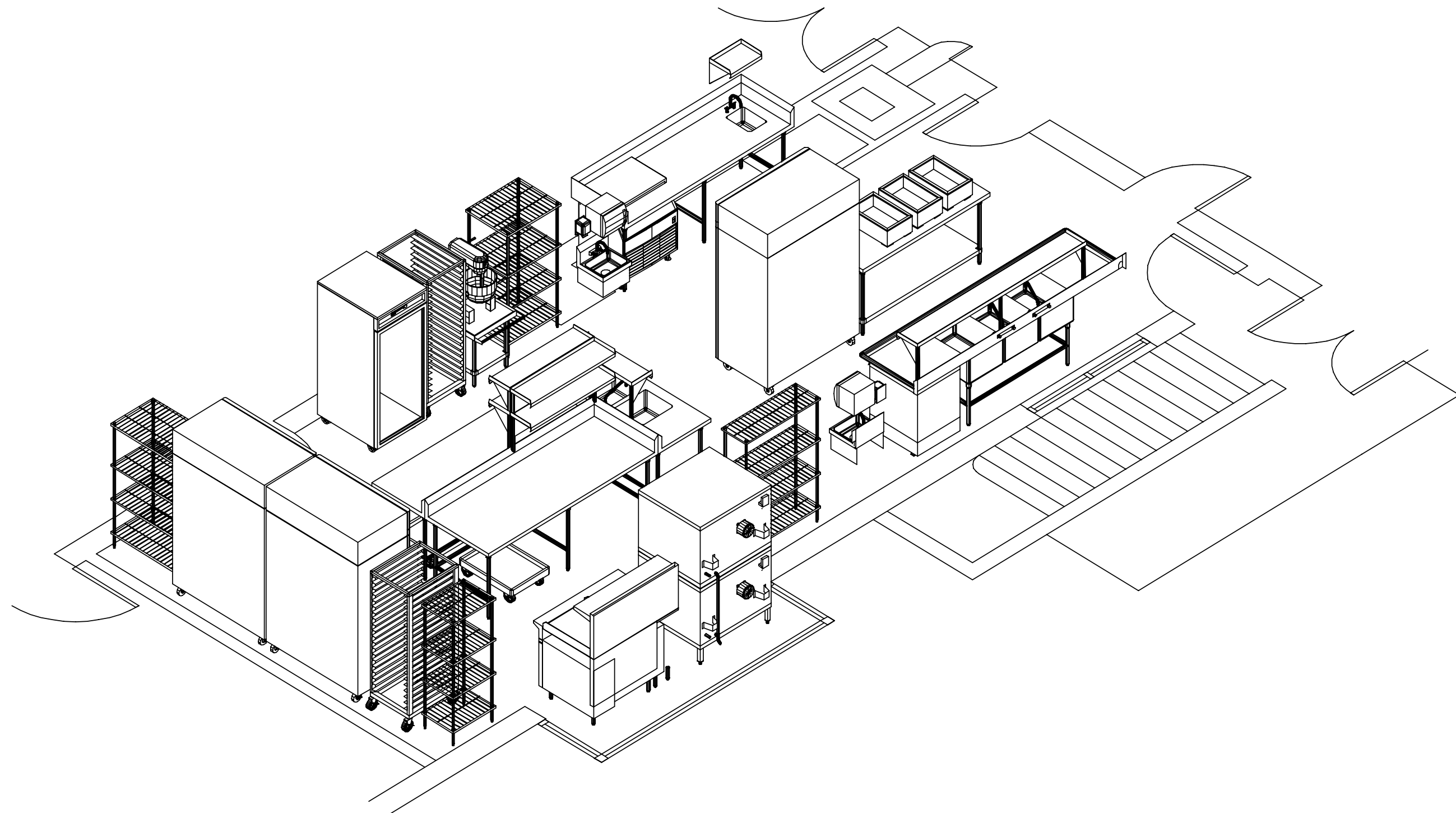

**HUFF-MORRIS ARCHITECTS**  
A PROFESSIONAL CORPORATION  
8 NORTH FIRST STREET  
RICHMOND, VIRGINIA 23219  
804.343.1505 VOICE HUFFMORRIS7 AOL.COM E-MAIL 804.343.1619 FAX

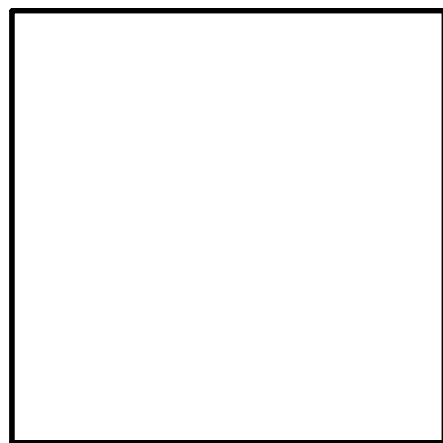

DATE: 12/18/20

REVISIONS:

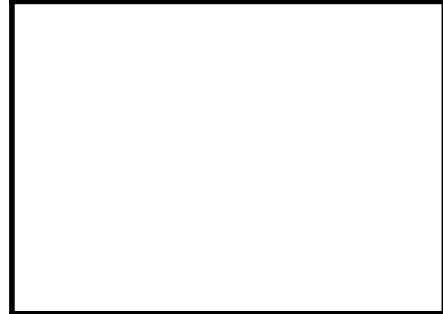

**WESTOVER HILLS METHODIST**  
RICHMOND, VA

FOOD SERVICE  
MAIN KITCHEN

FILE NO.:

—  
OF  
—

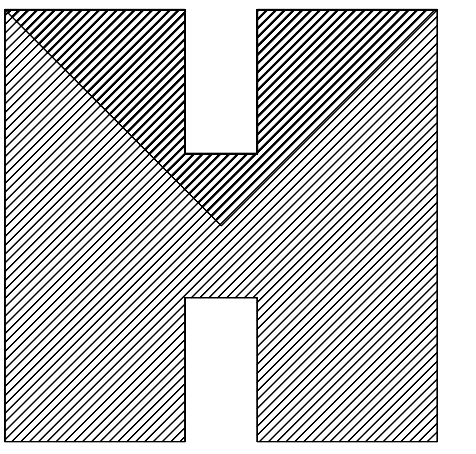

**HUFF-MORRIS ARCHITECTS**  
 A PROFESSIONAL CORPORATION  
 8 NORTH FIRST STREET  
 RICHMOND, VIRGINIA 23219  
 804.343.1505 VOICE HUFFMORRIS.P.AOL.COM E-MAIL 804.343.1619 FAX

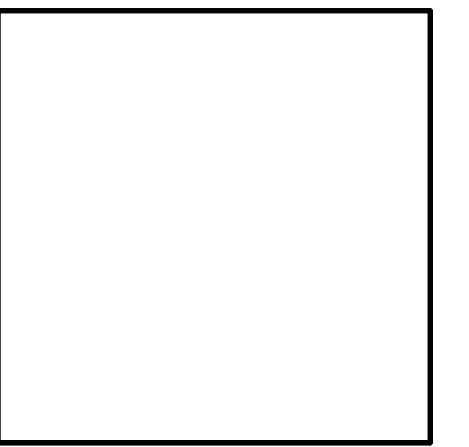
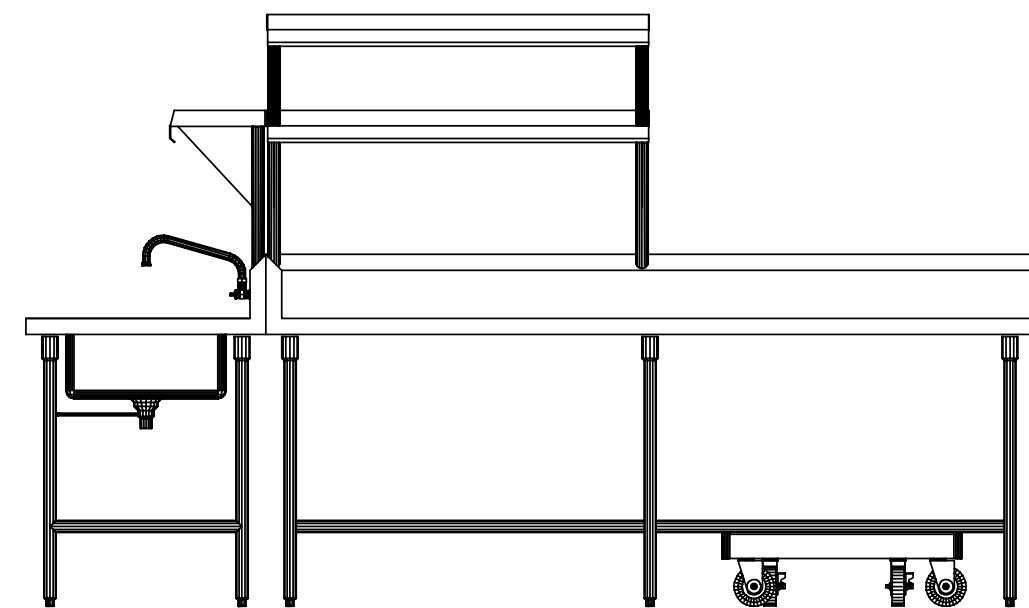
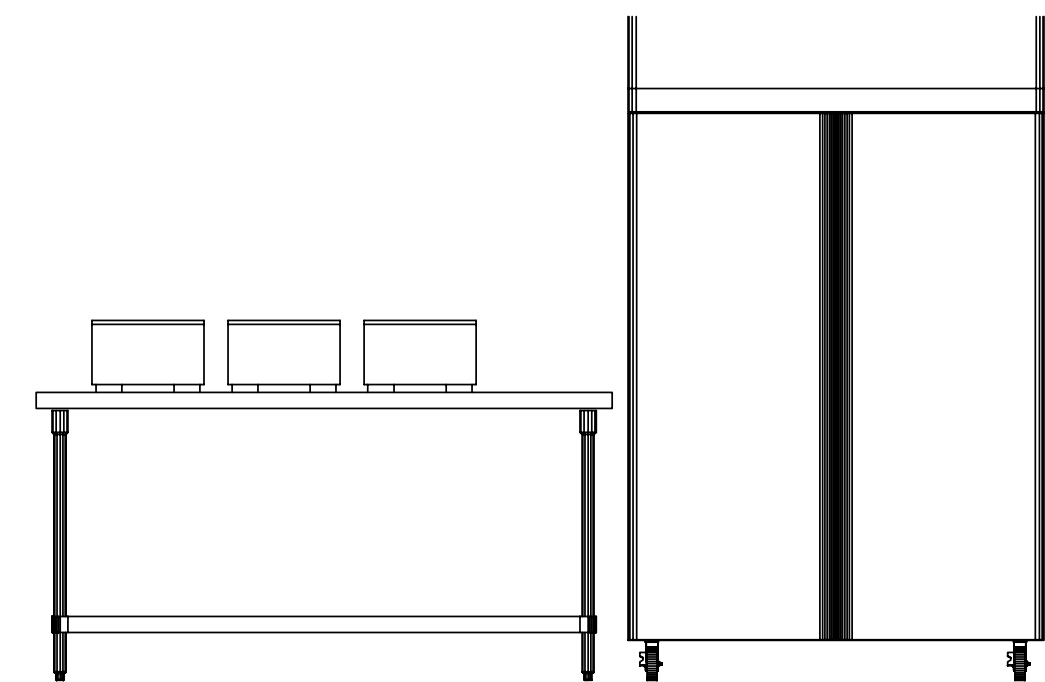
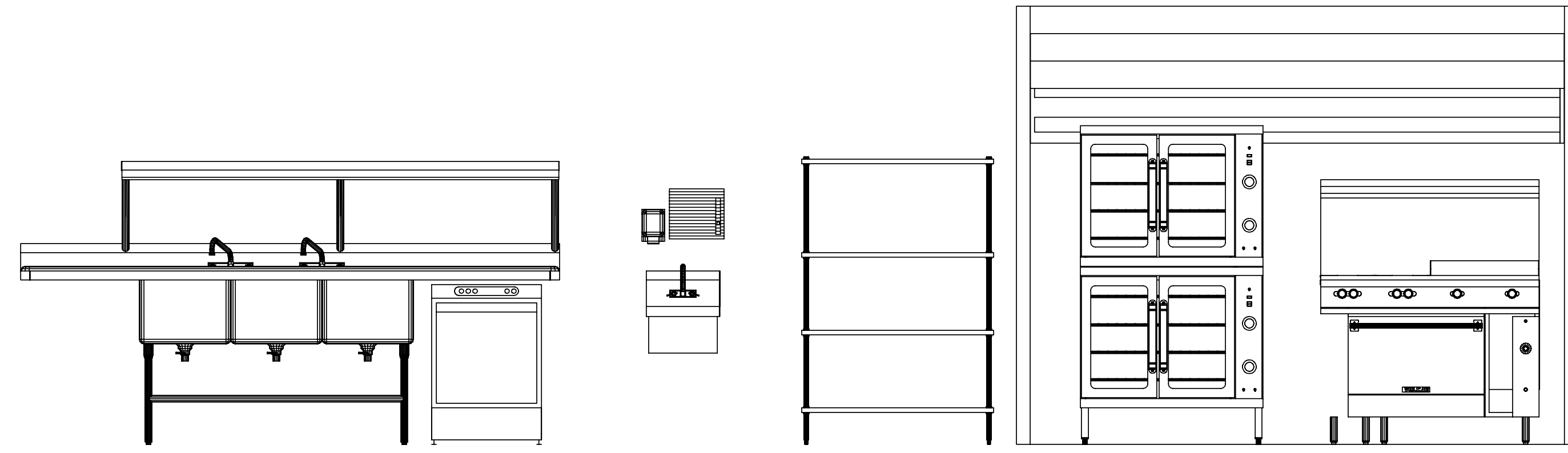
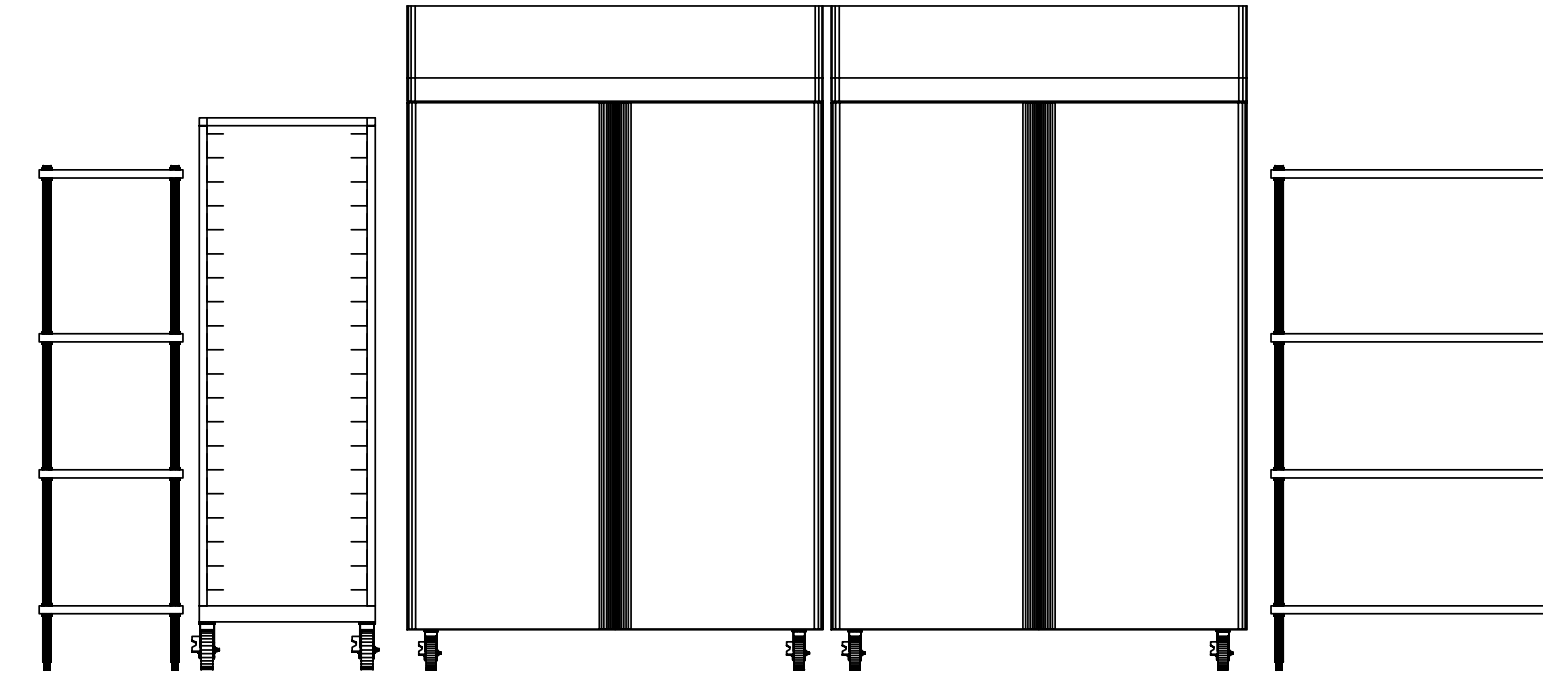
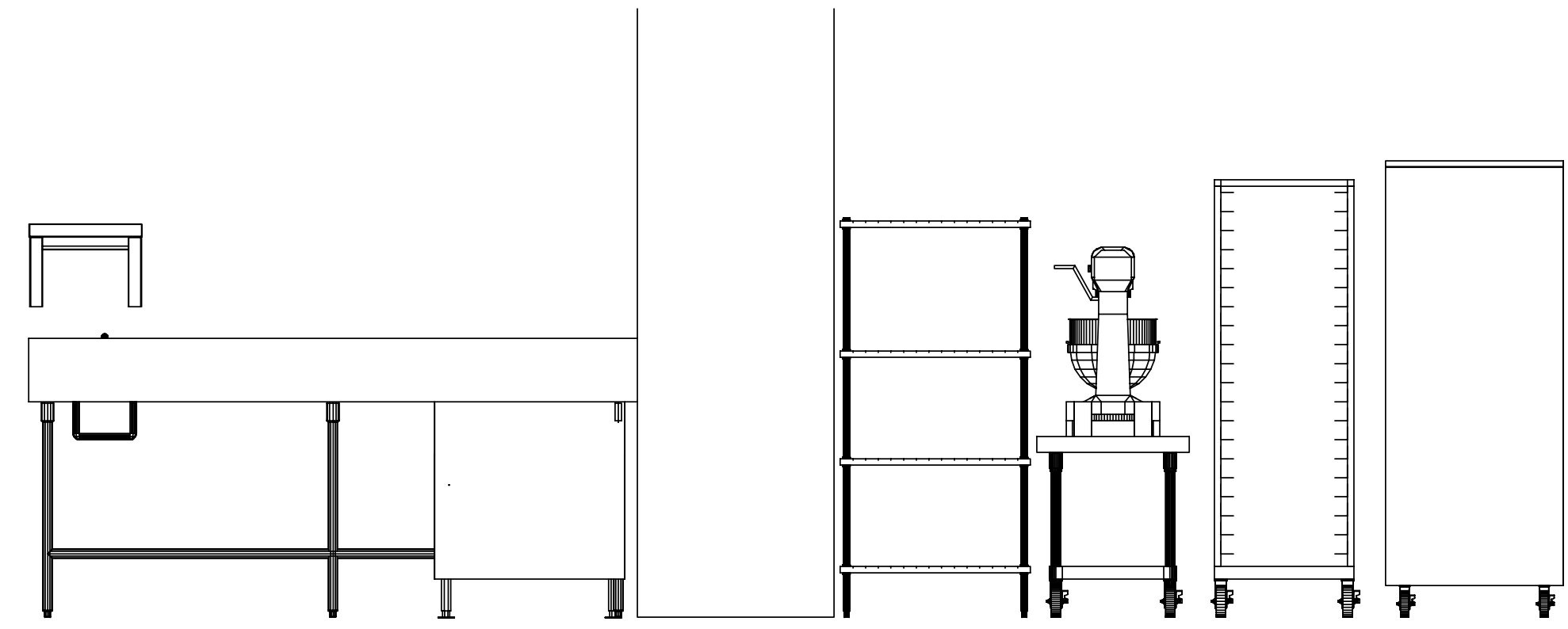

DATE: 12/18/20

REVISIONS:



**WESTOVER HILLS METHODIST**  
 RICHMOND, VA

FOOD SERVICE	
MAIN KITCHEN	
FILE NO.:	
OF	